

Article number: 2082265M10B

Description: E+G Mini indexing plunger
with/without rest position, GN 822.6-5-M10-B

Measures

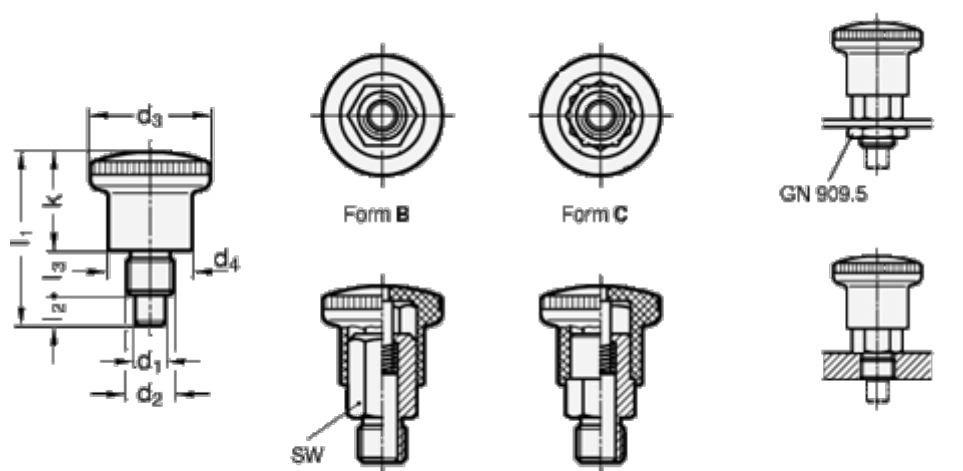

$d_1 = 5$

$d_2 = M10$

$d_3 = 25$

$d_4 = 18$

$k = 20.0$

$l_1 = 34.0$

$l_2 = 6$

$l_3 = 8$

Spring load initial $N = 6$